

THE NAVIGATOR

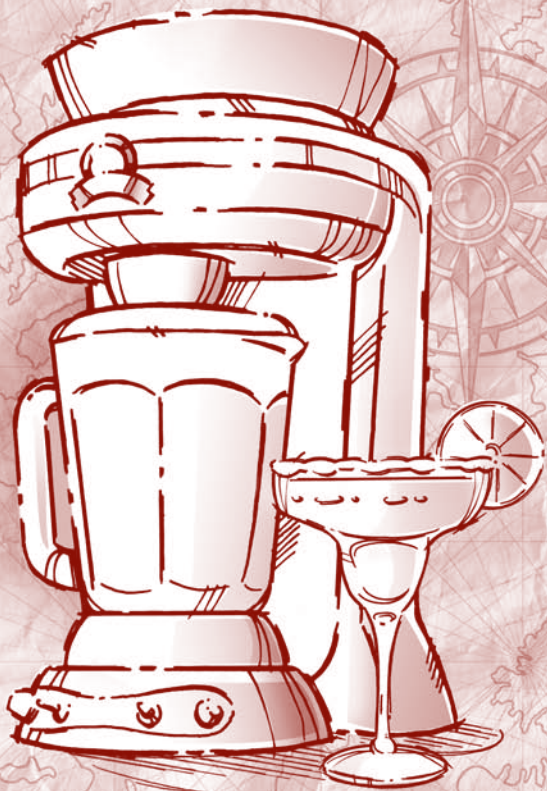

FROZEN CONCOCTION MAKER™

The Best Margaritas Come From Margaritaville.®



Model DM 1000 User Manual



WELCOME

*Congratulations on your purchase of the Margaritaville®
Frozen Concoction Maker™ – DM 1000!*

To learn more about Margaritaville® products,
please visit us at www.margaritavillecarg.com.

FROZEN CONCOCTION MAKER™

PARTS LIST

- 1 Ice Reservoir Lid – Covers the Ice Reservoir.
- 2 Ice Reservoir – Holds the ice for making frozen drinks.
- 3 Shaving Paddle – Moves ice across the Shaving Blade.
- 4 Ice Hopper – Feeds ice from reservoir to Shaving Blade.
- 5 Ice Shaving Blade – Shaves ice.
- 6 Shaving Blade Assembly Nut – Holds Shaving Blade in place.
- 7 Ice Chute – Directs ice from Ice Hopper into Blending Jar.
- 8 Blending Base – Holds Blending Jar securely in place.
- 9 Control Panel – Contains all necessary controls to operate your unit.

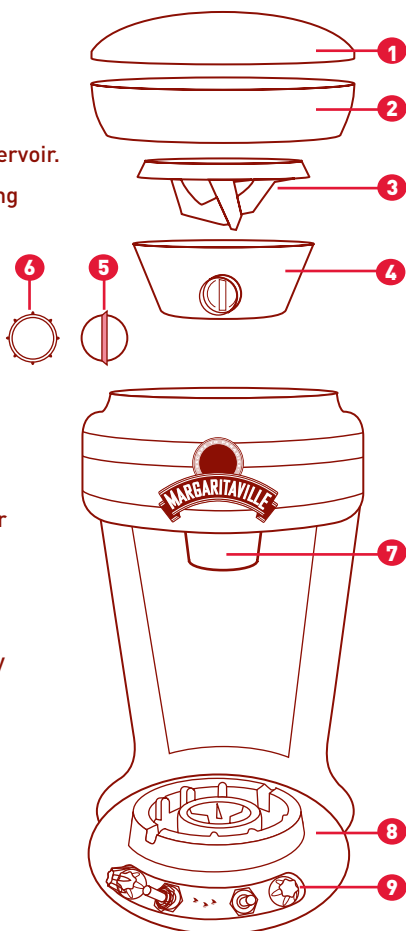

- 10 Jar Lid** – Seals the blending jar.
- 11 Glass Blending Jar** – Made from heavy-duty glass, has maximum capacity of 36 oz.
- 12 Blending Blade Sealing Ring** – Seals the blending jar and blending base.
- 13 Blending Blade** – Creates forward action when blending drinks.
- 14 Glass Jar Base** – Designed with wide base for stability.
- 15 Ice Reservoir Release Button** – Releases ice reservoir from unit.
- 16 Ice Melt Reservoir** – Contains melted ice excess.
- 17 Cord Storage Door** – Covers power cord storage area.

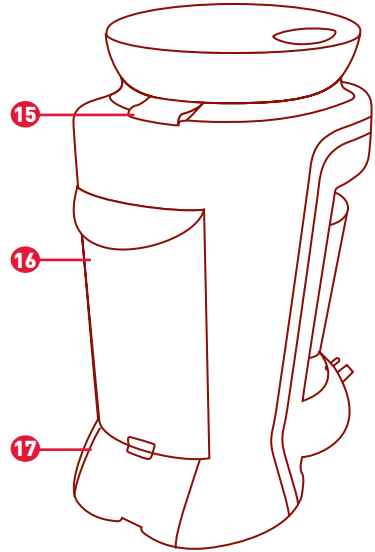
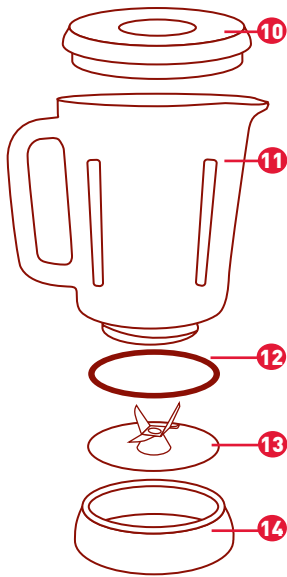

Control Panel

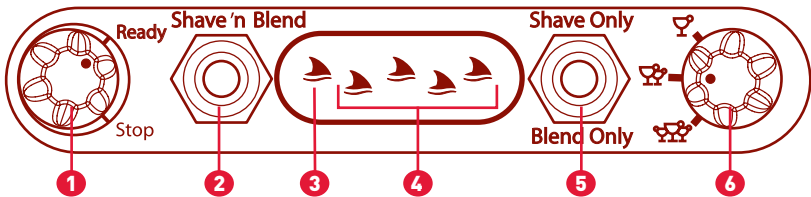

- 1 READY/STOP Rotary Switch** – Turns your unit on and off.
- 2 Shave 'n Blend™ Toggle Switch** – Used to select automatic Shave 'n Blend cycle.
- 3 Power Indicator Light** – Blinks when unit is plugged in to indicate ready for use.
- 4 Progress Indicator Lights** – Shows status of Shave 'n Blend cycle.
- 5 Blend Only/Shave Only Toggle Switch** – Used to manually operate ice shaver and blender.
- 6 Number of Drinks Rotary Switch** – used to select 1, 2 or 3 twelve oz. frozen drinks.



MAKING FROZEN DRINKS

1. Place the unit on a clean dry flat surface.
2. Place the Ice Reservoir on the unit front first, then push down firmly on back. Reservoir must click into place.

NOTE: IF ICE RESERVOIR IS NOT SEATED FIRMLY IN PLACE THE UNIT WILL NOT OPERATE.

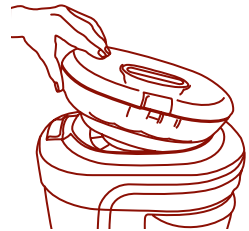

3. Remove the Cord Storage Door by pushing down on the release tab located on the Cord Storage Door. Remove the power cord and plug the unit into a standard 120 Volt wall socket. Replace the cord storage door and position the power cord in the slot below the cord storage release tab.

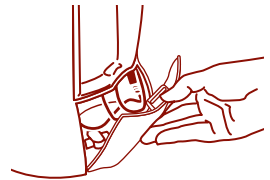

4. Remove the Ice Reservoir Lid using the Release Button located on the top of the Ice Reservoir.

NOTE: NEVER PUT ANYTHING BUT ICE IN THE ICE RESERVOIR.

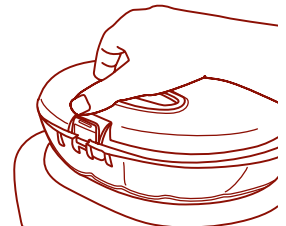

5. Fill the Ice Reservoir with ice cubes.



6. Replace the Ice Reservoir Lid and snap closed.
7. Lift and remove the Glass Blending Jar. The Ice Chute is spring-loaded and can be pushed up.
8. Remove Blending Jar Lid.
9. Add appropriate amount of liquid ingredients to the Blending Jar for the number of drinks being made (1, 2 or 3). The glass icons on the Blending Jar show the level of liquid required for 1, 2 or 3 frozen drinks.

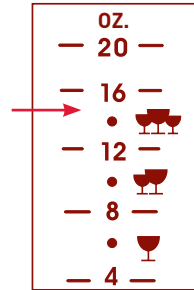

NOTE: DO NOT EXCEED THE THREE-GLASS ICON LEVEL OR THE GLASS BLENDING JAR COULD OVERFLOW DURING OPERATION.

The Best Margarita Recipe

Ingredients	Amount (12 fluid oz drink)					
	1 Drink		2 Drinks		3 Drinks	
	fl oz	ml	fl oz	ml	fl oz	ml
Margaritaville® Gold Tequila	1	30	2	60	3	90
Triple Sec	1/4	7.5	1/2	15	3/4	22.5
Lime Juice	1/2	15	1	30	1 1/2	45
Orange Juice	1/2	15	1	30	1 1/2	45
Margaritaville® Margarita Mix	1	30	2	60	3	90

10. Replace Blending Jar Lid and return Glass Blending Jar to Blending Base by pushing up on the Ice Chute with the Glass Blending Jar and then placing it on the Blending Base.

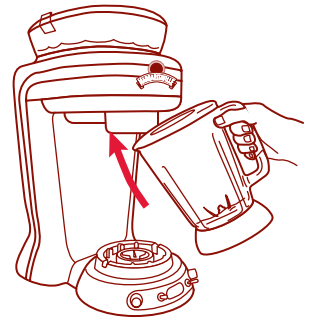

11. Set the Number of Drinks Rotary Switch to correspond to the number of drinks being made.
12. Rotate the READY/STOP Rotary Switch on the Control Panel to the READY position.

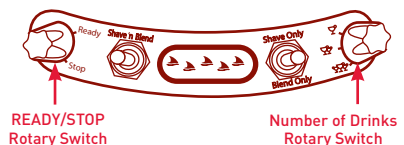

Automated Shave 'n Blend™ Cycle

13. Start the automatic shave and blend cycle by pushing up on the Shave 'n Blend™ Toggle Switch.

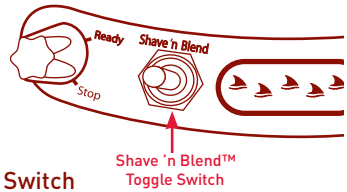

14. The unit will shave ice for the appropriate time (based on the Number of Drinks Rotary Switch setting). The blender will start automatically. The unit will stop at the completion of the cycle.

NOTE: DURING THE SHAVE AND BLEND CYCLE THE PROGRESS INDICATOR LIGHTS WILL ILLUMINATE IN A SEQUENCE FROM LEFT TO RIGHT TO INDICATE THE CYCLE PROGRESS.

15. The Power Indicator Light will blink to indicate the unit is ready to make more drinks.

16. To serve:

- a. Lift and remove the Blending Jar.
- b. Remove Blending Jar Lid.
- c. Pour and enjoy.



NOTE: To remove excess ice from the ice reservoir hold the Shave Only toggle switch in the Shave Only position until the Ice Reservoir is empty. **WARNING: DO NOT PLACE FINGERS IN THE ICE HOPPER. THE SHAVING BLADE IS SHARP AND COULD CAUSE INJURY.**

17. Turn off the unit.

18. Periodically check the Ice Melt reservoir and empty as needed.

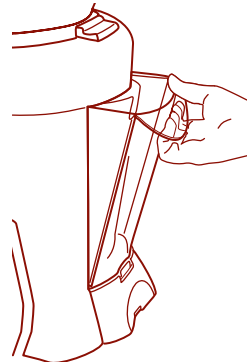

Manual Cycle

To make a thicker drink:

- a. Hold the “Blend Only/Shave Only” Toggle Switch in the Shave Only position to add more ice to the Blending Jar.
- b. To stop adding ice, release the toggle switch.
- c. To mix the newly added ice into the drink, hold the Blend Only/Shave Only Toggle Switch in the blend only position until the desired consistency is achieved. To stop the blending release the toggle switch.

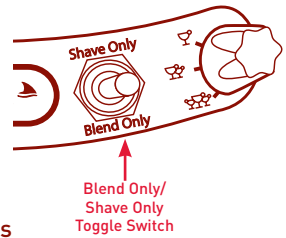

To make a thinner drink:

- a. Hold the Blend Only/Shave Only Toggle Switch in the Blend Only position until the desired consistency is achieved.
- b. To stop blending release the toggle switch.

CLEANING & MAINTENANCE

IMPORTANT: Your Glass Blending Jar, Shaving and Blending Blades are subject to wear during normal use. Always inspect for nicks, chips, or cracks. Always inspect for broken, cracked, or loose blades. If the jar or Shaving and Blending Blades are damaged, do not use. Call our toll-free customer service number, 1-877-689-2737, to obtain replacement parts.

1. Make sure unit is unplugged. Place on a clean dry surface. Turn the unit so the back is facing you. Push down on the Ice Reservoir Release Button. Lift the back of the Ice Reservoir and remove. This will expose the Shaving Paddle and Ice Hopper.

Note the location of the Shaving Blade inside the Ice Hopper.

WARNING: DO NOT PLACE FINGERS INSIDE THE ICE HOPPER NEAR THE SHAVING BLADE. BLADE IS SHARP HANDLE CAREFULLY.

2. To Remove the Shaving Paddle: Press the button located behind the Ice Chute. If the button cannot be pressed, rotate the Shaving Paddle for a half turn and retry.

While pressing the button, rotate the Shaving Paddle counter-clockwise (to the left) by placing fingers in the ridges of the Shaving Paddle and unscrew. This will expose the Ice Hopper and Shaving Blade.

To re-assemble the Shaving Paddle, simply replace it into the threaded insert and rotate clockwise. Hand tighten only.

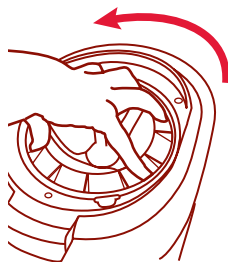
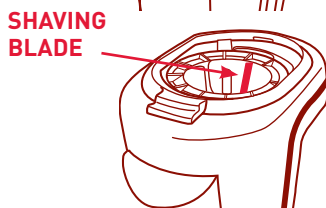
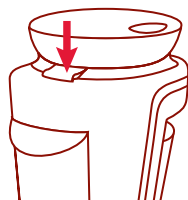

3. Press the two Ice Hopper release catches and lift the Ice Hopper to remove.

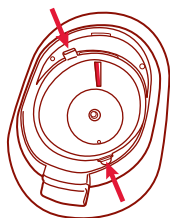

4. Turn the Shaving Blade Assembly Nut counter clockwise (to the left) and remove, then remove the Shaving Blade and store in a safe place.

SHAVING BLADE

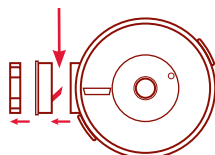

5. Carefully lift the Glass Blending Jar straight up to remove. The Ice Chute is spring-loaded and can be pushed up. If the Blending Jar is not easily removed, rock gently and lift. Do not twist.

6. Turn the Blending Jar upside down and unscrew the Jar Base counter clockwise (to the left). Carefully remove the Blending Blade, and Blending Blade Sealing Ring.

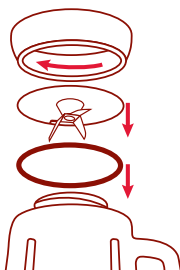

WARNING: THE BLENDING BLADE IS SHARP. HANDLE WITH CARE.

7. To remove the Ice Melt Reservoir hold the unit still and pull straight out on the handle.

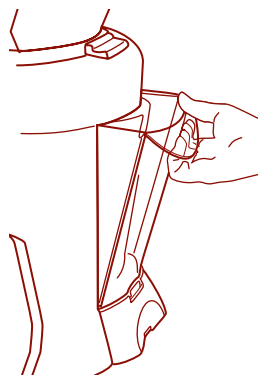

8. The Shaving Paddle, Ice Hopper, Shaving Blade Assembly Nut, Shaving Blade, Blending Jar Lid, Glass Blending Jar, Blending Blade, Blending Blade Sealing Ring, Jar Base and Ice Melt Reservoir can be safely washed in the top rack of your dishwasher. Use only top rack. Failure to do so will result in damage.

9. Use a damp cloth to clean the outside of the unit.

WARNING: UNPLUG UNIT BEFORE CLEANING. DO NOT USE SOLVENTS. NEVER IMMERSE THE UNIT IN WATER.

Troubleshooting

If the Power Indicator Light does not light:

Check that the unit is plugged into a working power outlet.

If liquid leaks from the base of the Glass Blending Jar:

Remove it from the unit and check that the Blending Blade Sealing Ring is properly installed and that the Blending Jar Base is tightened.

If water leaks from the unit: Empty the Ice Melt Reservoir.

If the Glass Blending Jar overflows during the Shave 'n Blend™ cycle:

Check that the liquid level is not above the three glass icons on the Glass Blending Jar.

If the Glass Blending Jar will not sit on the Blending Base:

Remove it from the unit and check for ice on the Blending Base.

WARNING: unplug the unit before removing ice from the Blending Base.

If the shaver does not shave sufficient ice for the liquid in the Glass Blending Jar:

Check that the Number of Drinks Rotary Switch setting corresponds to the amount of liquid in the Blending Jar.

Dos and Don'ts

DO NOT Place fingers into the Glass Blending Jar or Ice Hopper. The blades in this unit are sharp and could cause injury.

DO NOT place Glass Blending Jar onto Blending Base while motor is running. The spinning Blending Base could damage the Glass Blending Jar.

DO NOT twist Glass Blending Jar when removing. Simply lift and remove. Twisting the Glass Blending Jar could loosen the Blending Jar Base causing it to leak.

DO NOT put hot liquid into the Glass Blending Jar. Hot liquids could be ejected during the blending process causing injury.

DO NOT place ice, frozen foods or very cold liquids into a Blending Jar which has come directly from a hot dishwasher. The sudden change in temperature could cause the Blending Jar to crack.

DO NOT place very hot liquids or foods into a Blending Jar that has come directly from the freezer. The sudden change in temperature could cause the Blending Jar to crack.

DO Follow the Cleaning and Maintenance instructions prior to your first use.

DO unplug the unit when not in use.
